

Burnt-down restaurant "Zur Sonne"  
 Ruine d'incendie Auberge "Au Soleil"  
 Afgebrand pension "Zur Sonne"

Art. Nr. 130429

- D**
- Vor Beginn des Bastelns sollten Sie sich mit den Spritzlingen und der Anleitung vertraut machen.
  - Sollte es einmal vorkommen, daß ein Teil im Bausatz fehlt, kreuzen Sie bitte das fehlende Teil in der Anleitung an und schicken Sie diese bitte an Fa. Gebr. FALLER GmbH, Abt. Kundendienst, Kreuzstraße 9, 78148 Gütenbach. Sie erhalten dann umgehend Ersatz.
  - **In diesem Bausatz sind einige Kunststoffteile übrig.**
- GB**
- Before commencing with the assembly please familiarize yourself with the parts and read the instructions carefully.
  - In case of missing parts please indicate these on the instructions leaflet with a circle and return the leaflet to Gebr. FALLER GmbH, Kreuzstraße 9, D-78148 Gütenbach, Germany. You will receive the replacement by return.
  - **Some of the parts in this box are not needed to construct the model.**
- F**
- Avant de commencer le montage de votre maquette bien lire la notice et repérer les grappes.
  - Si une pièce manquait dans une boîte, cochez la pièce correspondante sur la notice et renvoyez la nous à Gebr. FALLER GmbH, Kreuzstraße 9, D-78148 Gütenbach (R.F.A.). Nous vous ferons parvenir la pièce par retour.
  - **Dans cette boîte se trouvent quelques pièces qui ne seront pas utilisées pour le montage.**
- NL**
- Vóór het bouwen zou men de gietstukken en de handleiding moeten bestuderen.
  - Indien onverhoopt een onderdeel aan het bouwpakket ontbreekt, gelieve men het ontbrekende deel in de handleiding aan te kruisen en deze te zenden aan Gebr. FALLER GmbH, Kreuzstraße 9, D-78148 Gütenbach. U ontvangt dan omgaand en gratis het ontbrekende onderdeel.
  - **Van dit bouwpakket worden enkele kunststof delen niet gebruikt.**



170492  
FALLER-EXPERT

Flüssigkleber in Plastikflasche mit Spezialkanüle für feinste Klebstoffdosierung.

FALLER-EXPERT

Liquid cement in plastic bottle with canule for very fine dosage.

FALLER-EXPERT

Colle liquide en bouteille plastique avec bec verseur pour un dosage précis.

FALLER-EXPERT

Vloeibare lijm in plastic-flacon met doserbuisje om nauwkeurig te lijmen.



170688  
Spezial-Seitenschneider zum gratfreien Abtrennen von feinsten Spritzteilen. Spitze 48° abgewinkelt. Nur für Polystyrol geeignet.

Special side cutter for cutting off ultra-fine moulded parts without burrs. Tip angle 48°. Only suitable for polystyrene.

Pince coupante spéciale pour couper sans bavure les pièces miniatures moulées par injection. Pointe coudée à 48°. Uniquement appropriée pour le polystyrène.

Speciale zijknijptang voor het braamloos afknippen van de fijnste gietstukdelen. Hoek snijvlakken 48°. Alleen geschikt voor polystyrol.



Inhalt	Spritzlinge	70150-01	1 x	70150-04	1 x	70150-07	1 x	70150-10	2 x
Contents	Sprues	70150-02	1 x	70150-05	1 x	70150-08	1 x	70576-06	1 x
Contenu	Moulages	70150-03	1 x	70150-06	1 x	70150-09	2 x	70460-01	1 x
Inhoud	Gietstukken								

## 2 Fensterfolie

Schnittmusterfolie für Fenster von Trägermaterial abziehen und auf die Fensterfolie mit gleicher Größe blasenfrei aufbringen (**ohne Klebstoff!**). Die benötigten Fenster werden ausgeschnitten und **ohne Schnittmusterfolie** auf die Rückseite der Fensterrahmen geklebt (Position laut Anleitung).

### Window foil

Pull off pattern sheet for windows from carrier and apply it, bubble-free, to the window foil of the same size (**without any glue**). Cut out the required windows and glue them to the rear side of the window frame **without pattern sheet** (position as to instructions).

### Feuille fenêtre

Retirer la feuille matrice pour fenêtre du matériel support et l'appliquer sur la feuille-fenêtre de même dimension sans que des bulles ne se produisent (**sans colle**).

Découper le nombre de fenêtres nécessaires et les coller **sans la feuille** modèle sur l'arrière des dormants (position selon instructions).

### Raam folie

Knippatroonfolie voor de ramen van schutblad afhalen en zonder blaasjes op het raam folie van dezelfde grootte aanbrengen (**niet lijmen!**). De benodigde ramen worden uitgeknipt en **zonder de knippatroonfolie** op de achterzijde van de raamkozijnen gelijmd (positie volgens handleiding).

#### ACHTUNG:

Farbrückstände vom patinieren unbedingt von allen Klebeflächen entfernen !

#### ATTENTION:

Before glueing please make sure to remove all patina colour remains from all surfaces to be glued !

#### ATTENTION:

Les résidus de peinture générés par la patine sont à enlever de toutes les surfaces à encoller

#### BELANGRIJK:

Verfresten van het patineren van alle lijmvlakken verwijderen !

## Fensterschnittmuster 130429

Sa. Nr. 230 688 0

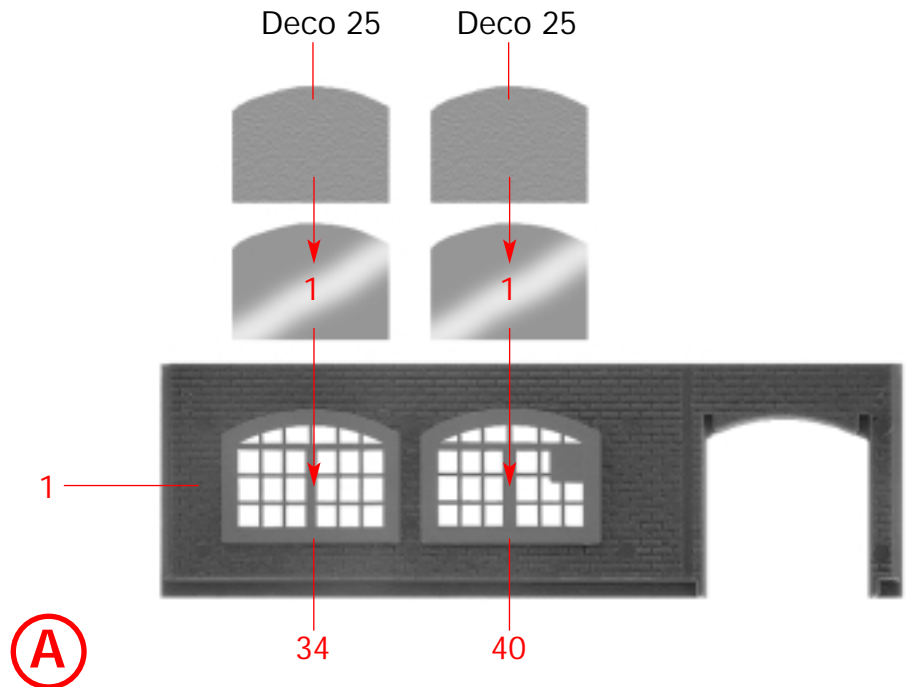
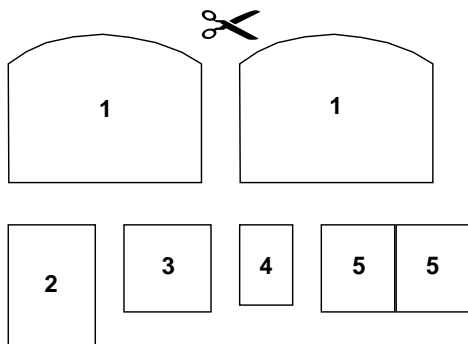

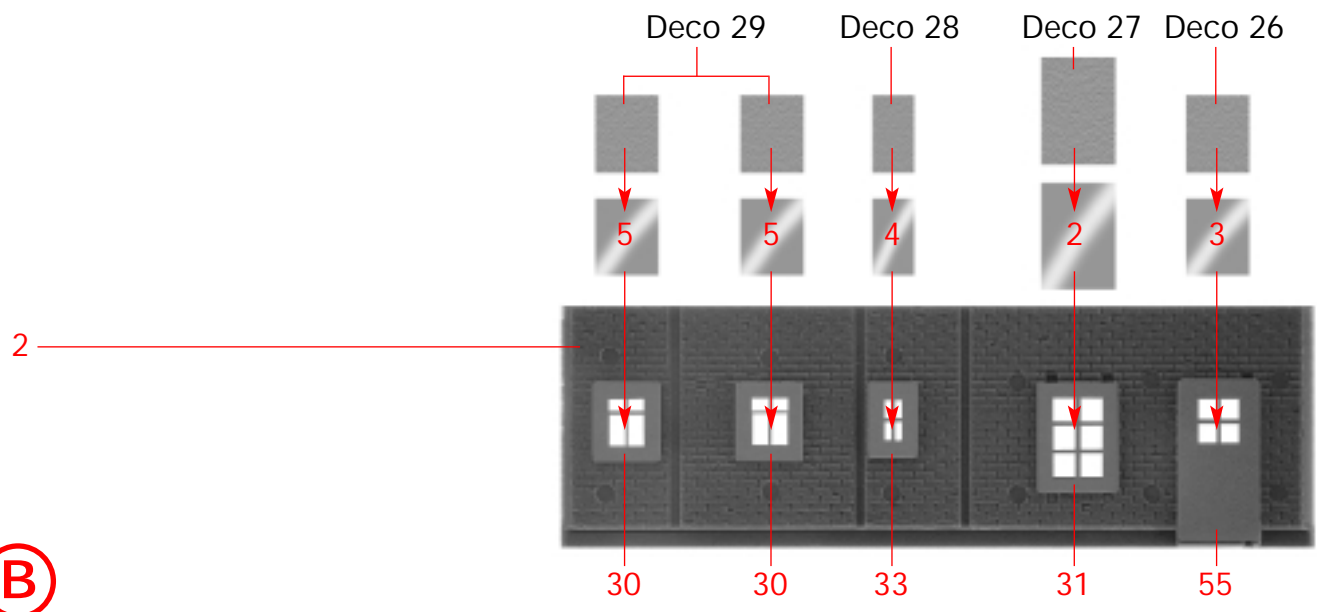

(B)

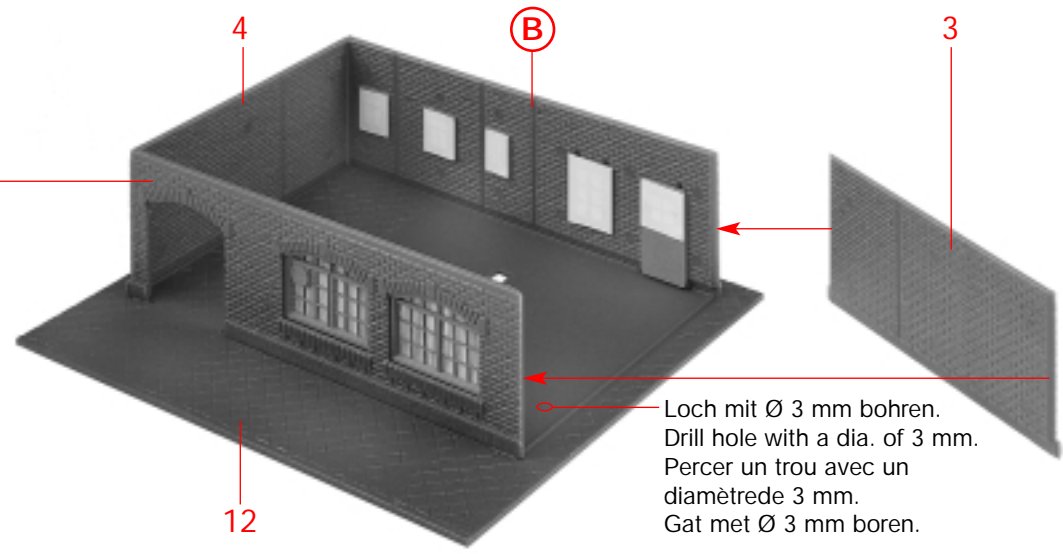

(C)

4

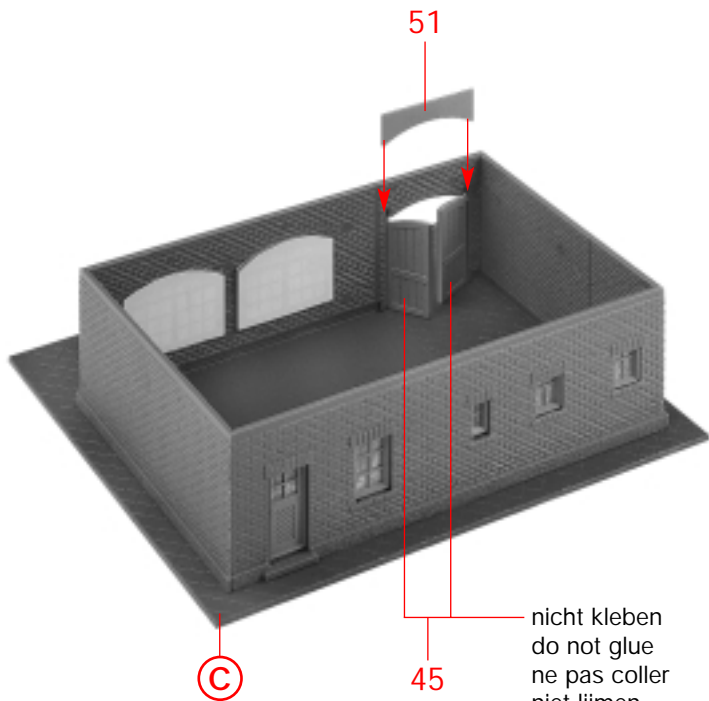

nicht kleben  
do not glue  
ne pas coller  
niet lijmen

F

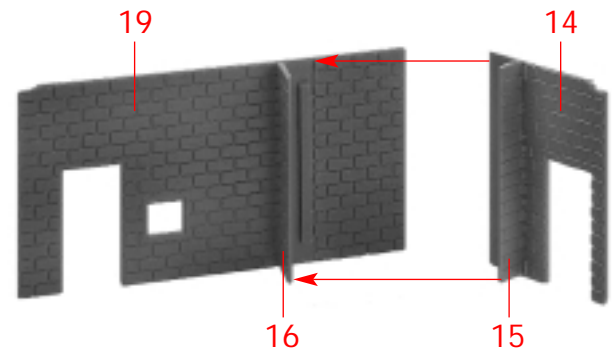

F

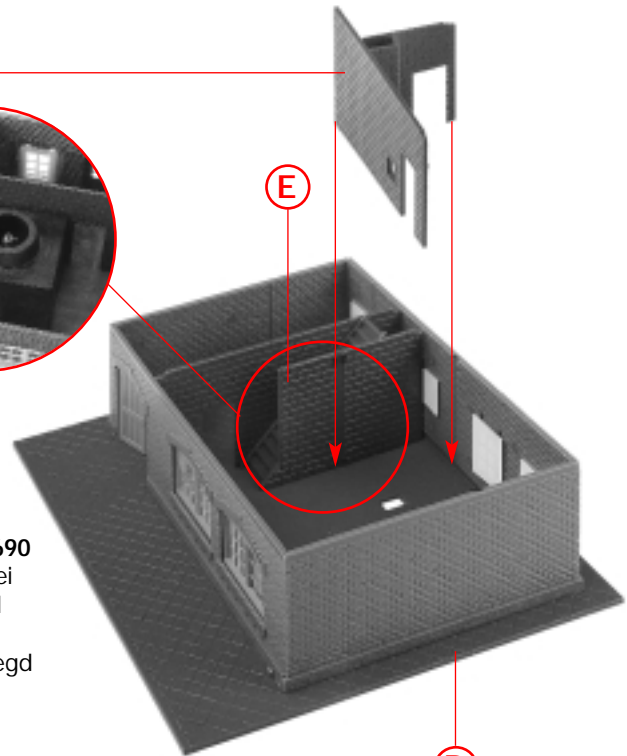
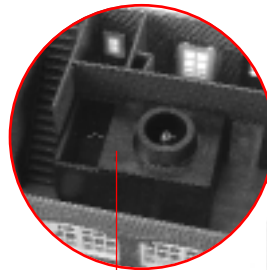

Art.-Nr.180690  
liegt nicht bei  
not included  
non jointe  
niet bijgevoegd

G

D

D

C

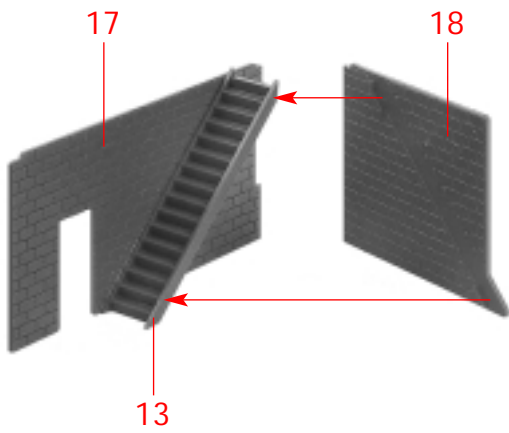

E

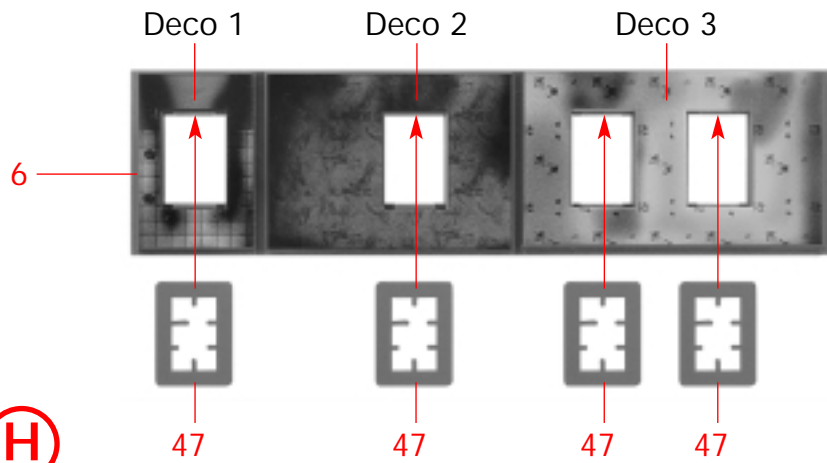

H

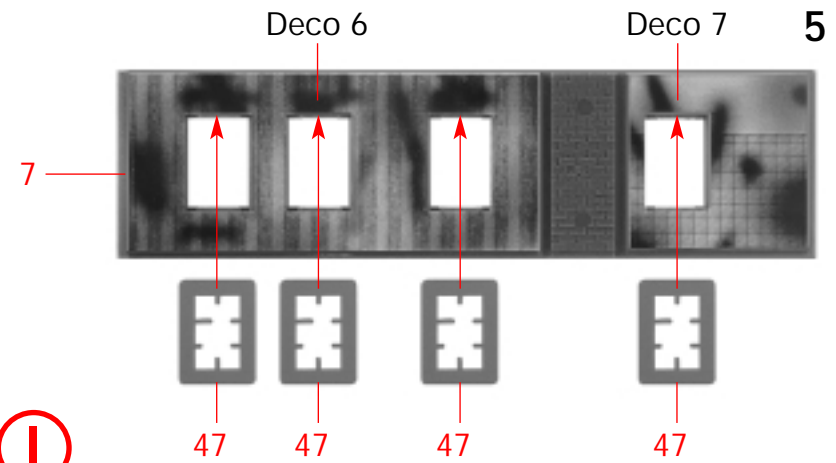

I

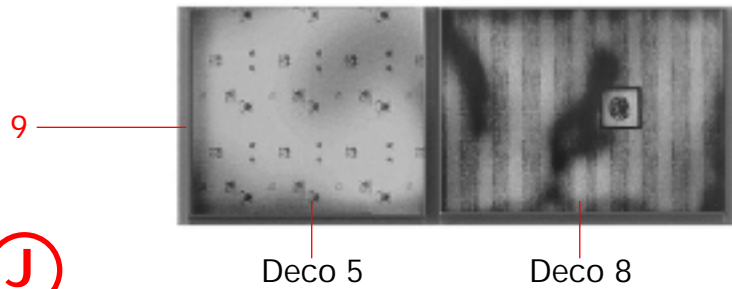

J

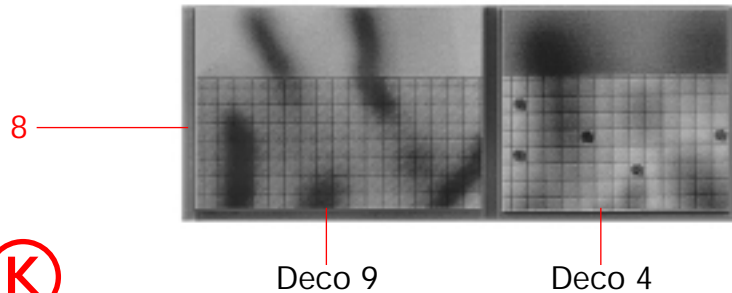

K

Art. 180690: Loch mit Ø 10 mm bohren. Drill hole with a dia. of 10 mm.  
Perçer un trou avec un diamètre de 10 mm. Gat met Ø 10 mm boren.

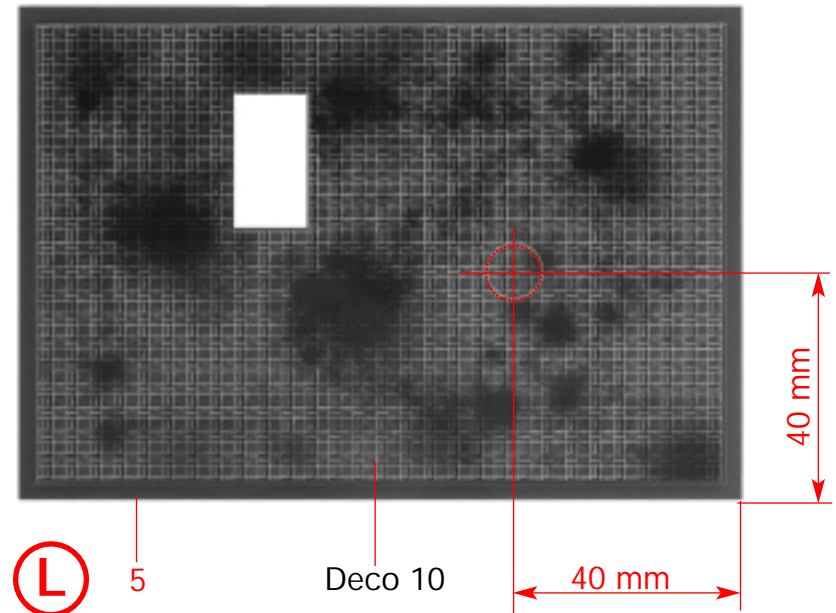

L

6

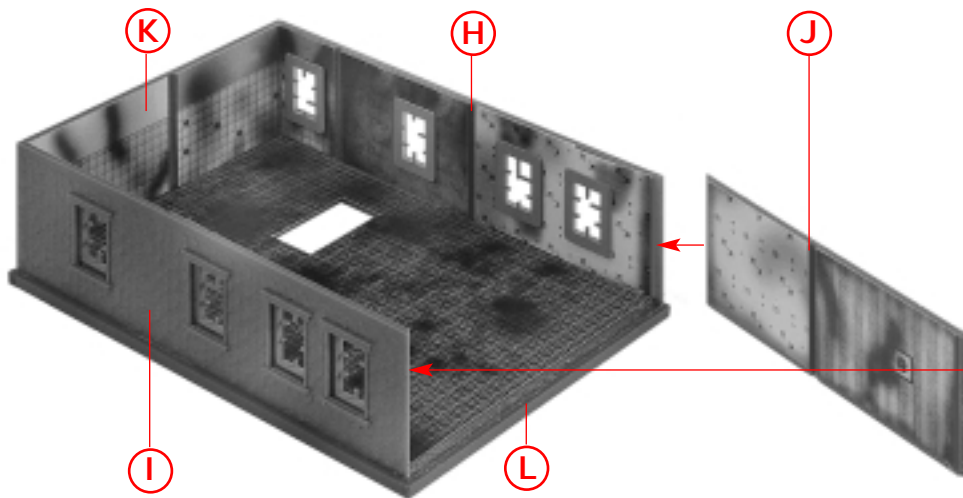

(M)

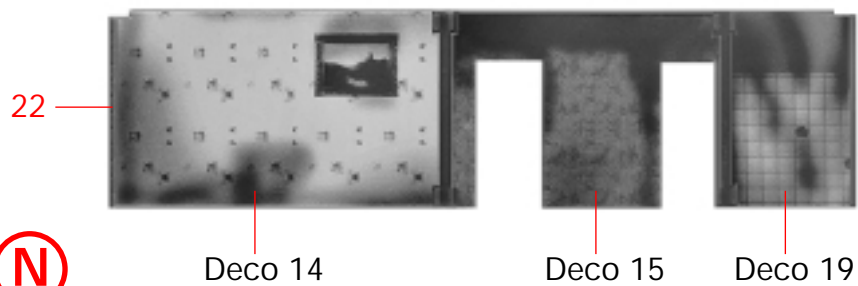

(N)

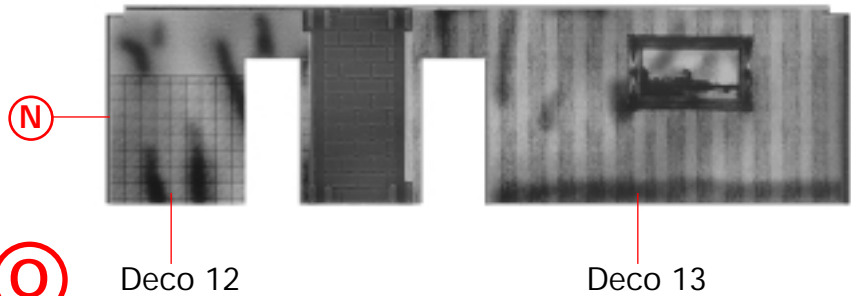

(O)

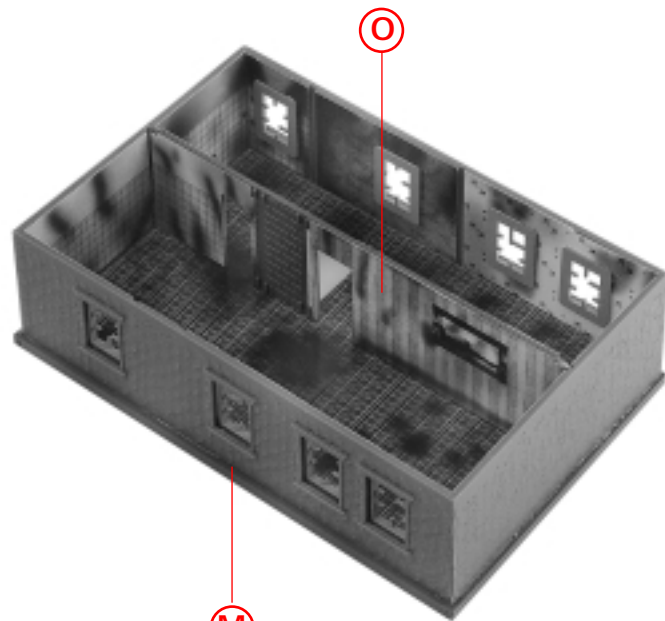

(P)

(M)

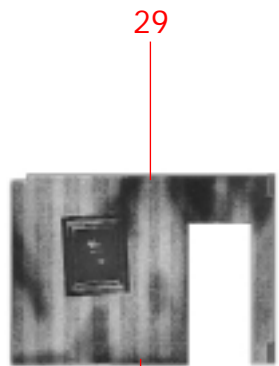

**Q** Deco 11

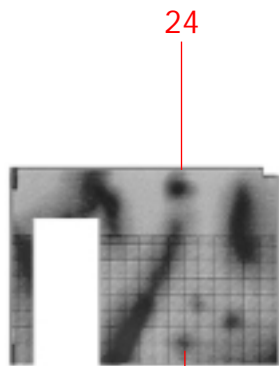

**R** Deco 17

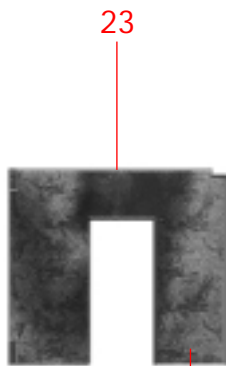

**S** Deco 20

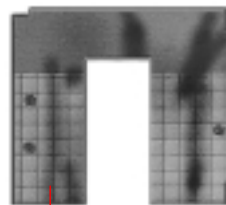

Deco 22

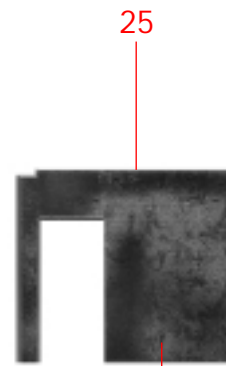

**T** Deco 21

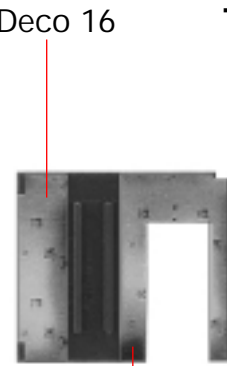

Deco 18

Deco 31



**U** 26

Deco 32



**V** 27

Deco 33



**W** 28

**T**

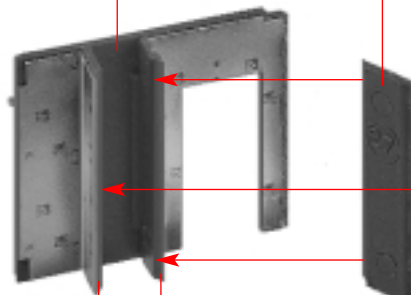

**V**

**X** **U** **W**

**R**

**Q**

**S**

**X**

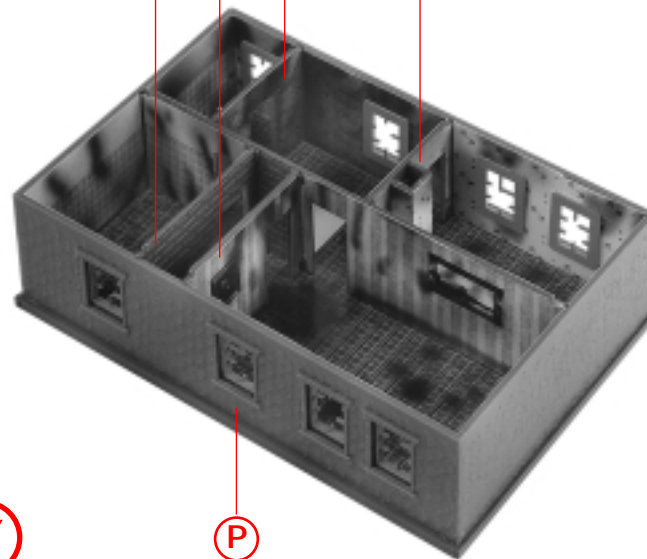

**Y**

**P**

8



**(a)**



**(b)**

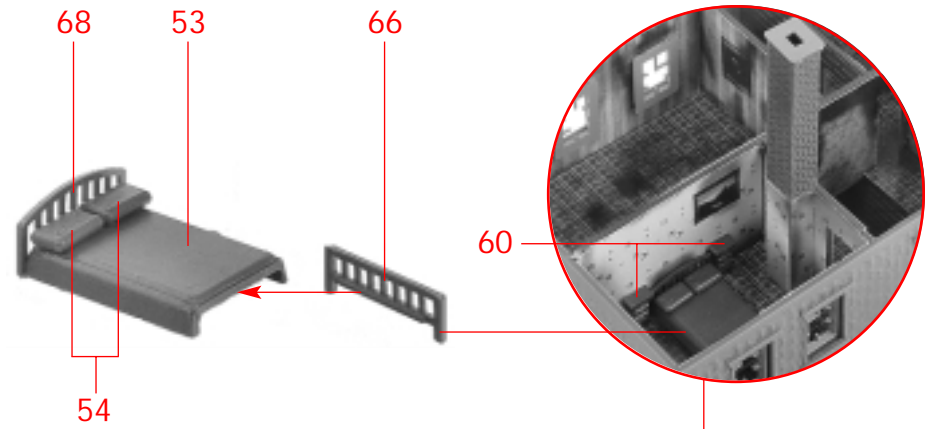

**(c)**

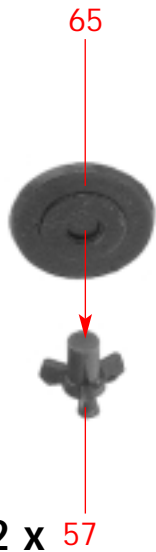

**(c)** 2 x 57



**(d)** 4 x 56



**(e)** 63

**(f)**

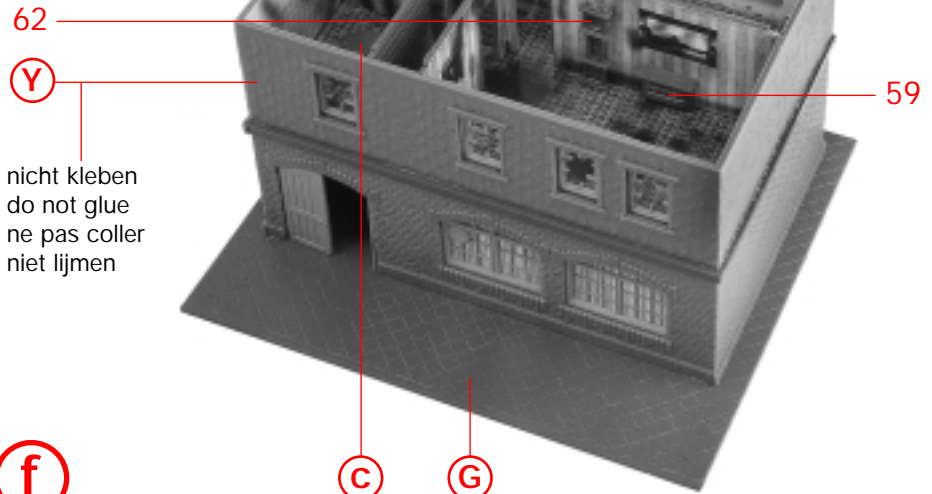

**(y)**

nicht kleben  
do not glue  
ne pas coller  
niet lijmen

**(c)**

**(g)**



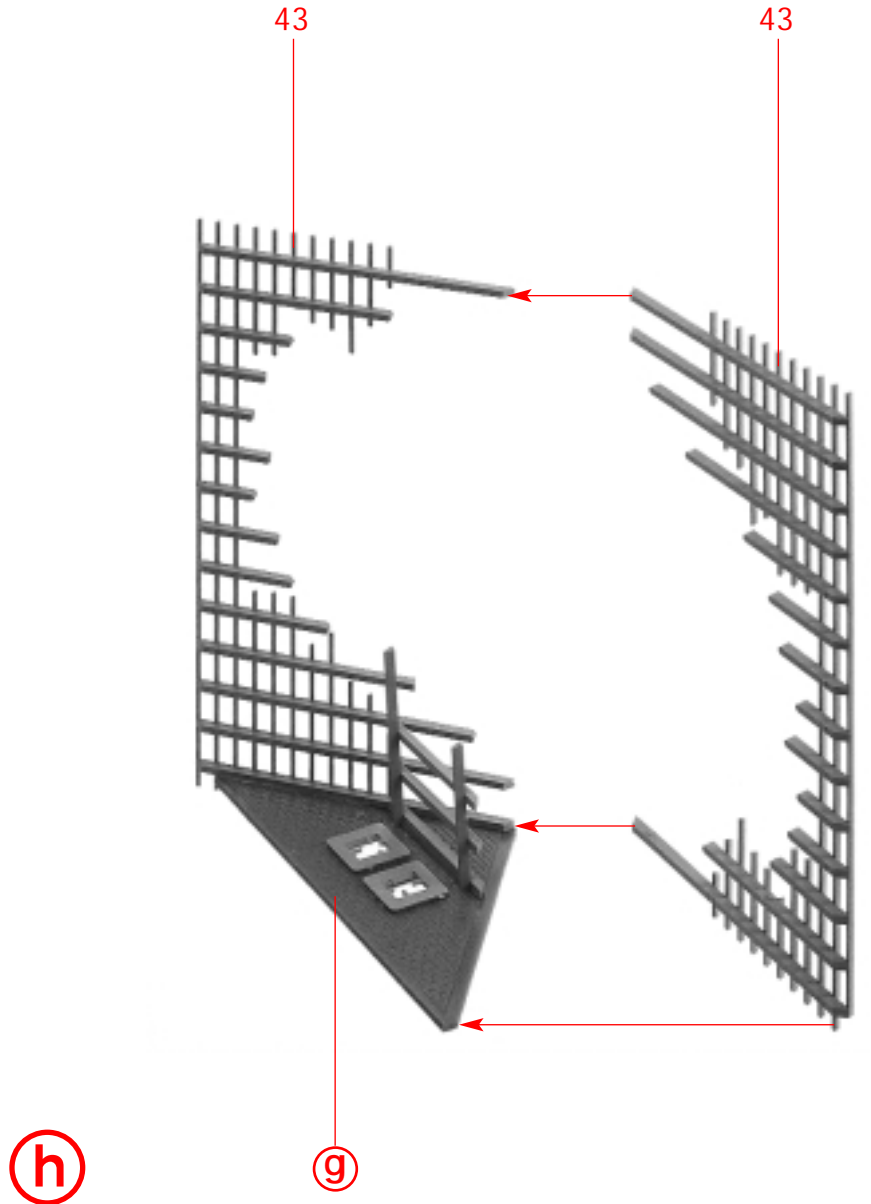
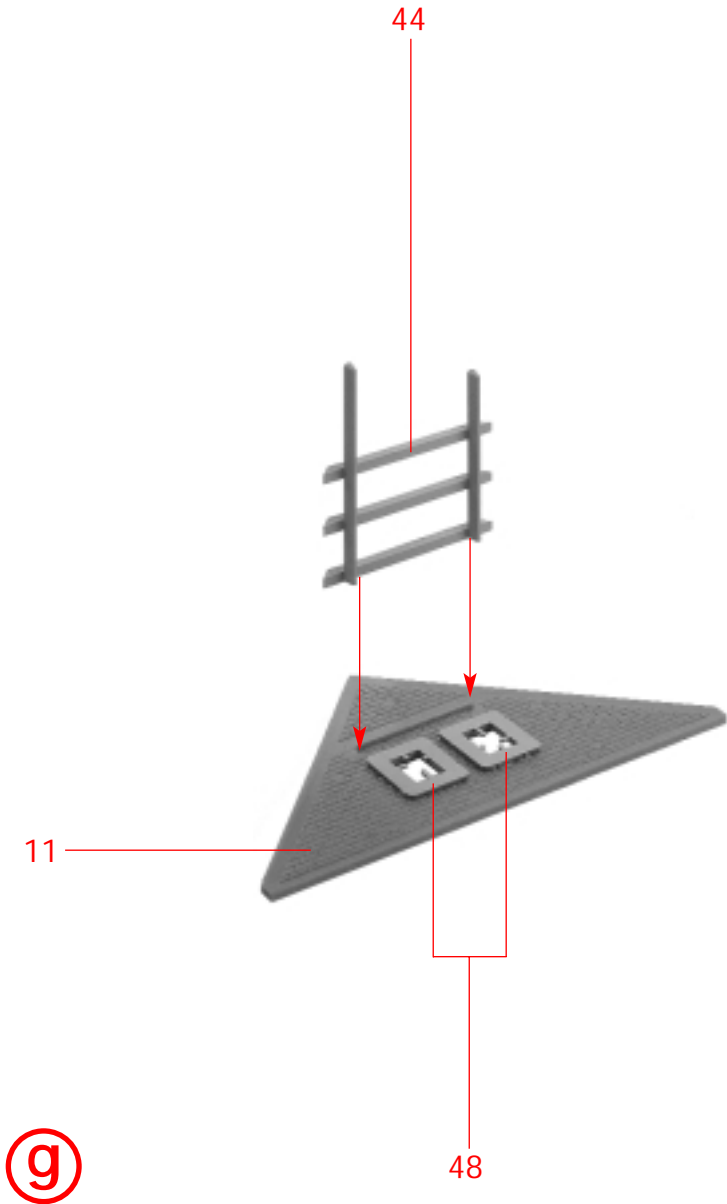

10

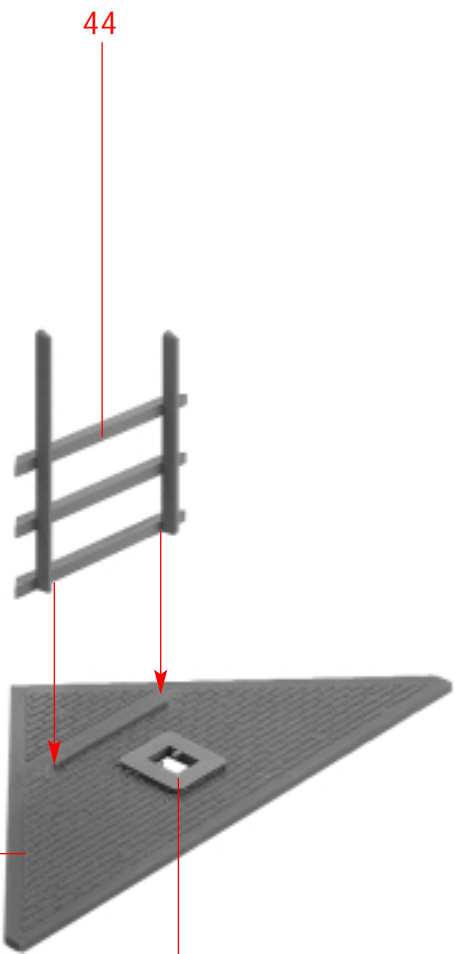

10

i

49

j

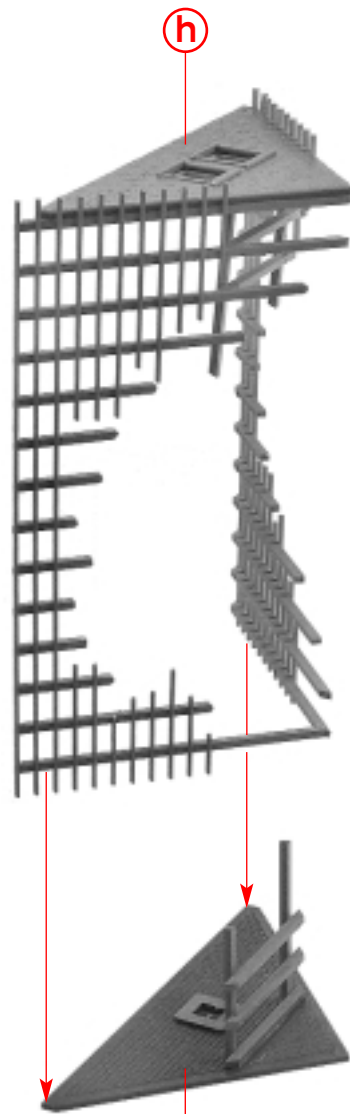

h

i

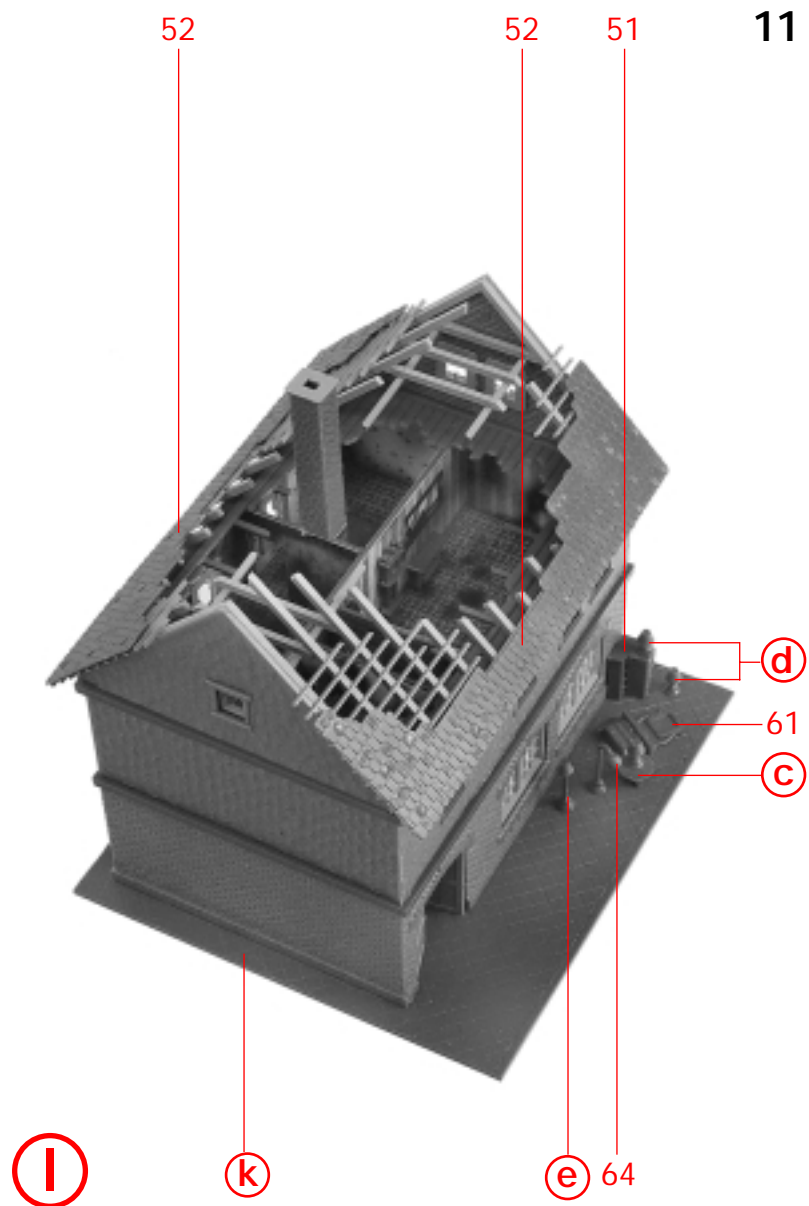
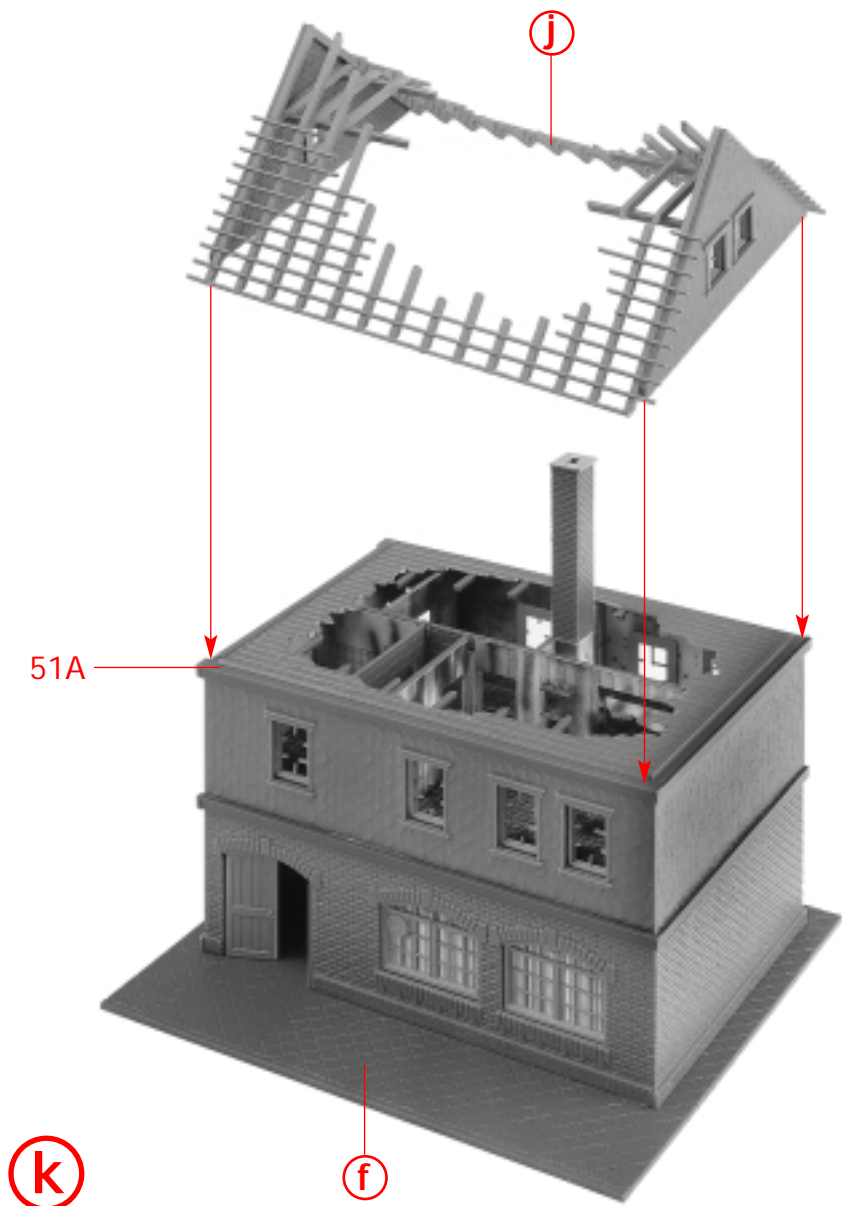

12

38

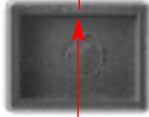

Menue 1	Menue 2
Suppe	Suppe
Braten	Zander
Gerichte	Gerichte
Dessert	Ca.

Deco 24

m

39



Gasthaus zur Sonne

Deco 23

n

n

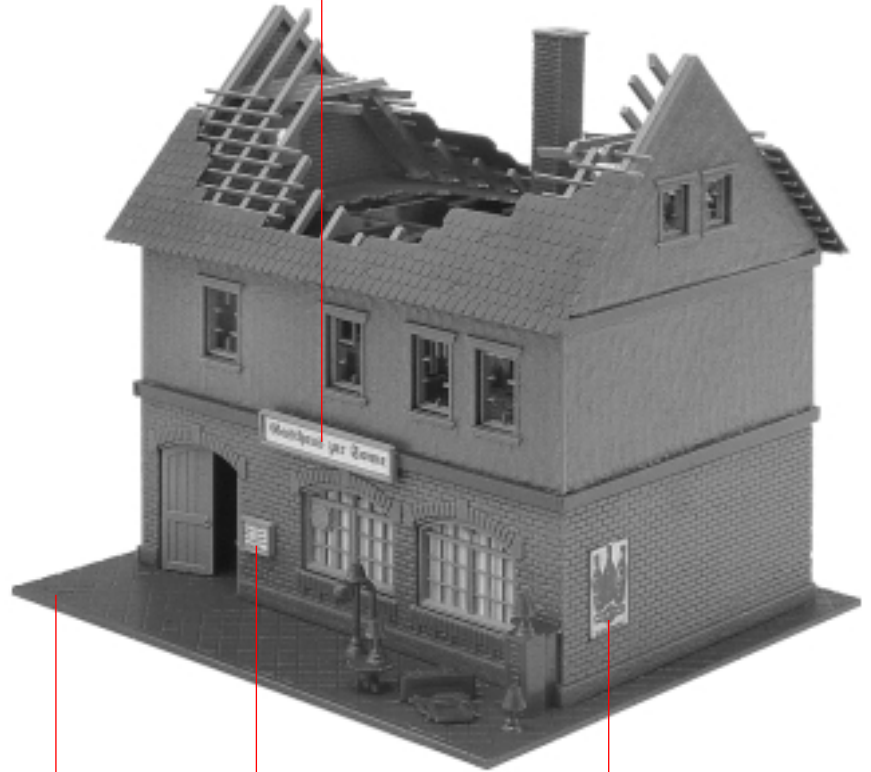

o

l

m

Deco 30